

Door cross sections - Measurements

UNIVER multipurpose doors



UNIVER
multipurpose

One-leaved doors Horizontal cross section

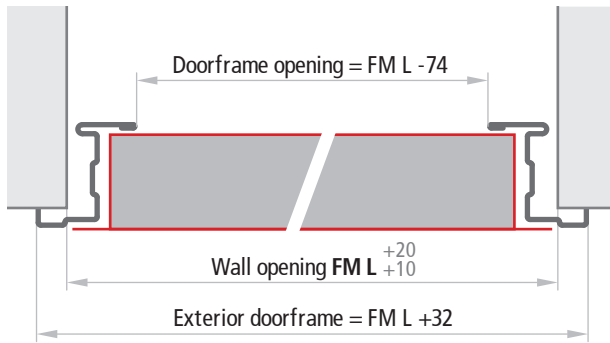

Doors without lower threshold Vertical cross section

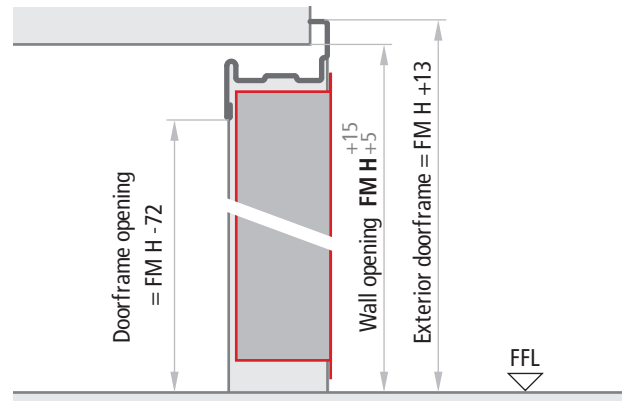

Doors with internal and external lower threshold Vertical cross section

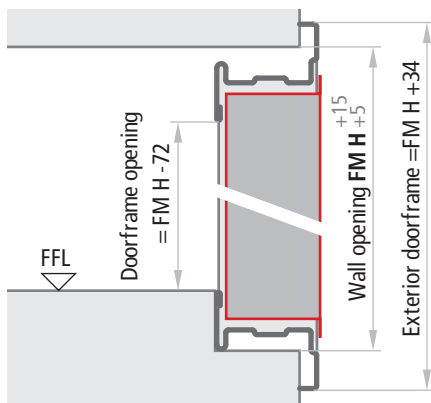

Doors with internal lower threshold Vertical cross section

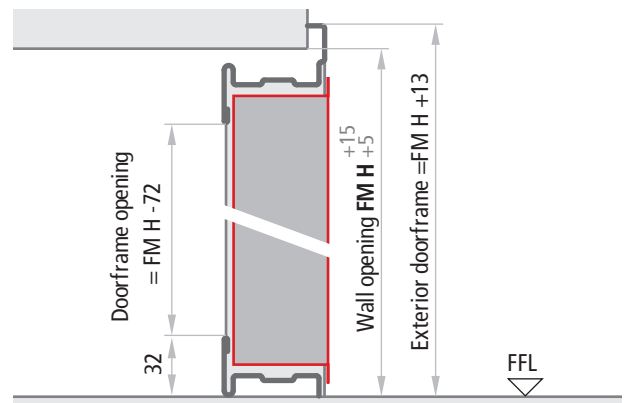

Two-leaved doors Horizontal cross section

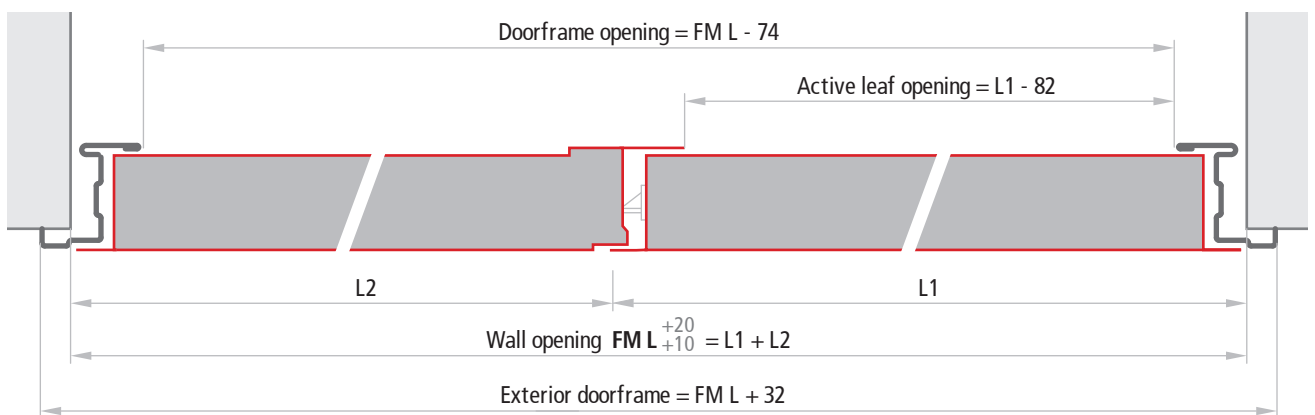

Leaf thickness

MULTIPURPOSE	50 mm
--------------	-------

NOTE

The tolerances $FM L +20$, $FM H +5$ of the indicated measurements make it easier to fill the gap between the wall and the doorframe with cement mortar. For dry wall installation, the holes must be precise and greater tolerance ranges should not be employed.

FFL = Finished Floor Level

INSTALLATION WITH ANCHORS FOR MORTAR FIXING



For mortar fixing, appropriate cuts will need to be created in the walls (section 80 x 200 mm) or the anchors should be fixed with expansion screws. The anchors should be bent and blocked inside the wall. For best mechanical hold, the space between the doorframe and the masonry should always be filled with concrete mortar or polyurethane foam.

INSTALLATION FOR EXPANSION SCREWS FIXING

For the installation with expansion screws, the anchors serve as spacers and should not be bent. Using Würth type art. 0910436112 plugs or similar (supplied at the customer's expense), installation is done with expansion screws into the pre-drilled holes present on the frame. For the best mechanical hold, the space between the doorframe and the masonry should always be filled with concrete mortar or polyurethane foam.

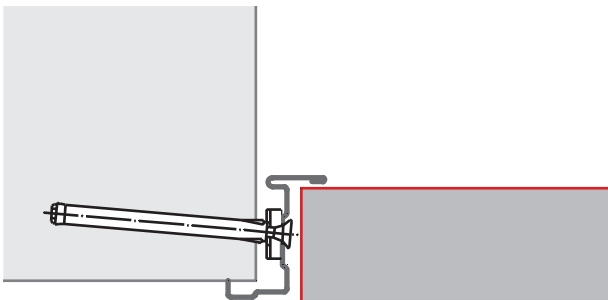

ANCHOR POSITIONING

One-leaved doors

Right opening

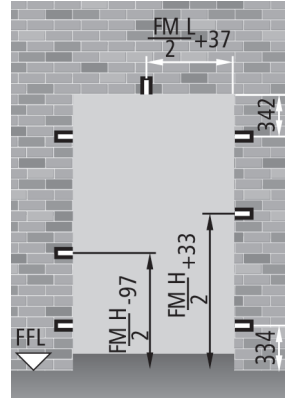

Left opening

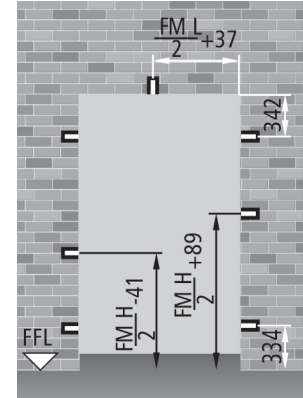

Two-leaved doors

Right opening

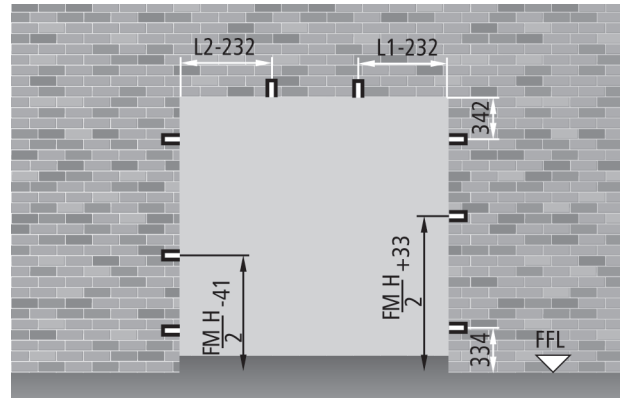

Left opening

